

Specifications

Device	Combiner	RSI
Voltage	600 Vdc	24 Vdc ± 3%
Total Current	48 Adc	N/A
DC Input	24 Vdc ± 3%	24 Vdc ± 3%
Compatibility	Up to 3 PV input strings per combiner	Controls up to 6 combiner boxes
Overcurrent Protection	(6) 600 Vdc DIN rail fuse holders	N/A
Power Draw	0.10 Adc	0.06 Adc
Enclosure Rating	UL Type 3R	UL Type 3R
Ambient Temp.	-25 to 60°C	-25 to 60°C
LED indicators	N/A	SOLAR ON SOLAR OFF AFCI (not used with SkyBox)
Knockouts	2", ½", ¾"	½"

Listings

- UL® 1741
 - including PVRSS
- CSA C22.2
 - including PVRSS

Compliance

- FCC Part 15, Class B

NOTES:

- ❖ The DC input and output circuits are isolated from the enclosure.
- ❖ The photovoltaic system grounding shall be installed according to the requirements of Sections 690.41 through 690.47 of the National Electric Code (ANSI/NFPA® 70). The installer is responsible for all system grounding.
- ❖ Use only UL514B-compliant wet location or rain-tight conduit hubs for entry into the enclosure.

Dimensions

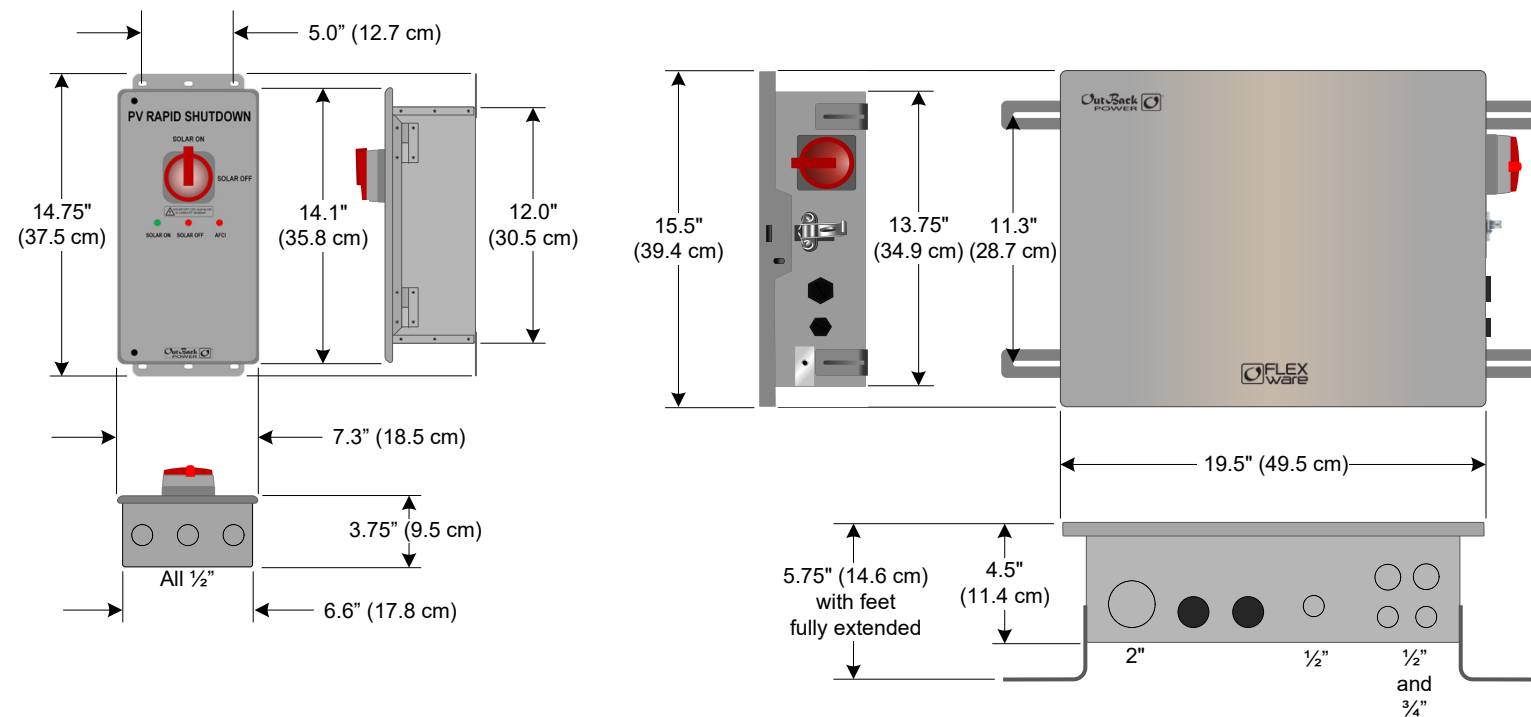

Rapid Shutdown Solution (RSD-1)



IMPORTANT

This document is for use by qualified personnel familiar with photovoltaic (PV) systems. Users of this document should meet all local and governmental code requirements for licensing and training for the installation of electrical power systems with AC and DC voltage up to 600 volts. This product is only serviceable by qualified personnel.

The RSD-1 works in conjunction with the SkyBox™ True Hybrid Energy System. It allows a system to meet the 2014 National Electric Code requirements for PV systems.

Features:

- End-to-end solution listed to UL1741 with PV rapid shutdown systems (PVRSS)
- Type 3R enclosures rated for indoor or outdoor installation
- Flexible design — install the combiner box vertically or horizontally and mount to racking or under an array
- Interoperability with compatible third-party PV rapid shutdown devices (PVRSE with dry contact)

Components Included:

- **Combiner Box**
 - FWPV3-FH600-S2D (600 Vdc, 2 pole)
- **Rapid Shutdown Initiator Box**
 - RSI



IMPORTANT

An isolated Class 2 DC power supply with the following specifications must be used to power the RSI:

- ❖ 24 Vdc ± 3% maximum over input voltage, ambient temperature, output load, and initial accuracy
- ❖ Up to 1.5 Adc

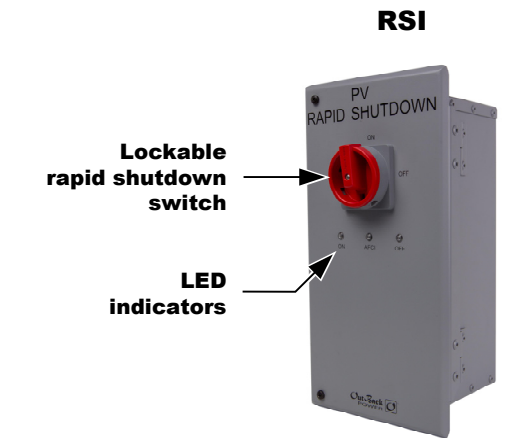
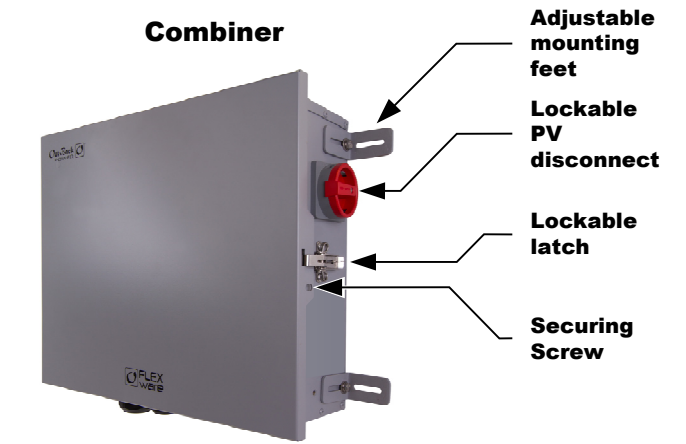

Accessories Available:

- **Box of (10) 15A Fuses**
 - FUSE-15-600VDC
- **Box of (10) 20A Fuses**
 - FUSE-20-600VDC
- **30A, 1000 Vdc Fuse Holder**
 - FH-30-1000VDC-DIN
- **PV Rapid Shutdown Label**
 - LBL-PVRSS

Installation (SAVE THESE INSTRUCTIONS)

Wiring

This document contains important instructions that shall be followed during installation and maintenance of the power system.

Mounting:

IMPORTANT
The surface and fastening hardware must be able to support the weight of all products.

- 1) Remove any necessary knockouts.
- 2) Mount the RSI box using the holes located in the mounting brackets. (See **A**.)
 - Secure the RSI appropriately for the mounting type.
 - The RSI box should be installed near the service meter. It must be mounted vertically and must be at least 36" (91.4 cm) above the ground.
- 3) Mount the combiner box using the four mounting feet. During shipping, these feet are attached facing inward. They should usually be repositioned facing outward for mounting as shown in **B**. The feet are slotted for exact spacing requirements in differing locations.
 - Secure the combiner appropriately for the mounting type.
 - The combiner box can be mounted horizontally, vertically, or at any intermediate angle. It must be mounted at least 36" (91.4 cm) above the ground. See **C**.
 - To meet PVRSS requirements, mount the combiner within 10' (3m) of the PV array. (Required distance may vary with local code requirements.)

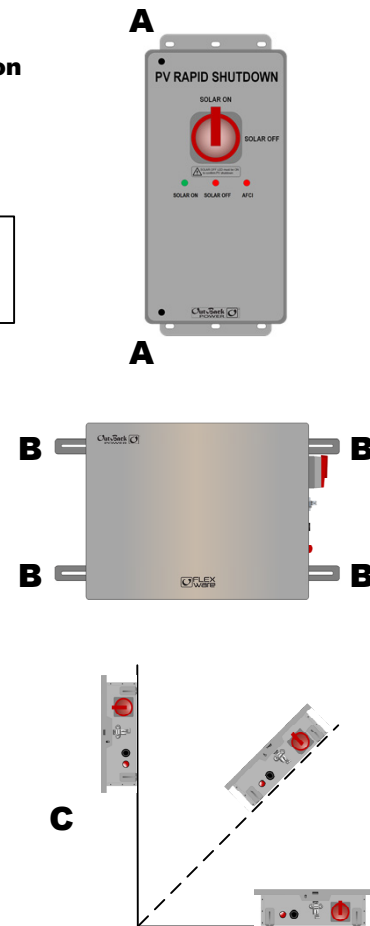

Torque Requirements by Wire Size (copper conductors only)

Cable Size*	Negative (-) Combiner TBB (large holes)	Negative (-) Combiner TBB (small holes)	Ground TBB	Ground Lug (combiner)	Contact Terminal
2/0 AWG (70 mm ²)	50 in-lb (5.7 Nm)	—	—	—	50 in-lb (5.7 Nm)
1/0 to #1 AWG (50 mm ²)	50 in-lb (5.7 Nm)	—	—	50 in-lb (5.7 Nm)	50 in-lb (5.7 Nm)
#2 to #3 AWG (35 mm ²)	50 in-lb (5.7 Nm)	—	—	50 in-lb (5.7 Nm)	50 in-lb (5.7 Nm)
#4 AWG (25 mm ²)	45 in-lb (5.1 Nm)	—	35 in-lb (4.0 Nm)	45 in-lb (5.1 Nm)	45 in-lb (5.1 Nm)
#6 AWG (16 mm ²)	45 in-lb (5.1 Nm)	—	35 in-lb (4.0 Nm)	45 in-lb (5.1 Nm)	45 in-lb (5.1 Nm)
#8 AWG (10 mm ²)	40 in-lb (4.5 Nm)	25 in-lb (2.8 Nm)	25 in-lb (2.8 Nm)	40 in-lb (4.5 Nm)	40 in-lb (4.5 Nm)
#10 AWG (6 mm ²)	35 in-lb (4.0 Nm)	20 in-lb (2.3 Nm)	20 in-lb (2.3 Nm)	35 in-lb (4.0 Nm)	35 in-lb (4.0 Nm)
#14 to #12 AWG (2.5 to 4 mm ²)	35 in-lb (4.0 Nm)	20 in-lb (2.3 Nm)	20 in-lb (2.3 Nm)	35 in-lb (4.0 Nm)	35 in-lb (4.0 Nm)

NOTES

- ❖ The large cable gland in the combiner box requires a torque value of 29.2 ft-lb (39.5 Nm) to retain the Type 3R rating. The small cable gland requires a torque value of 19.2 ft-lb (26.0 Nm). Tighten each sealing nut until it is almost even with the rest of the gland. (See the next sheet.)
- ❖ Minimum rating for all wires is 90°C. The exception is for PV source circuits above 50°C, which require wire rated for 105°C to avoid derating.

Wiring:

NOTE:
These instructions assume the use of one combiner, the RSI, and a battery source. (The SkyBox must be installed according to the appropriate instructions.)

- 1) Ensure all electrical sources to the system are disconnected. These include utility grid, PV, and batteries.
- 2) Wire all system components as noted below. See the next sheet for wiring illustrations. Note that battery connections and SkyBox internal wiring are not depicted.
 - Connect the red and black terminals on the RSI port labeled **J2** (24 Vdc supply) to the red and black terminals on the combiner port labeled **J1**.
 - Connect the white terminal on the RSI **J2** port to the white terminal on the combiner **J1** port.
 - Connect the PV array positive (+), negative (-) and ground to the combiner fuse holders and terminal bus bars (TBB).

NOTE: PV input wiring must be outdoor rated. It must be suitable for both wet locations and UV exposure.

 - Connect the combiner positive (+), negative (-) and ground to the load center bus bars. Connect the RSI ground to the load center ground bar.
- 3) Tighten all connections to the torque values on the table to the left.
- 4) Connect PV and other sources. Apply power to the system as appropriate.



CAUTION: EQUIPMENT DAMAGE
The 24-volt negative conductor is not grounded and is not to be connected to chassis or any other grounding system.

Other Wire Sizes

Connection	Minimum*	Maximum*
Combiner Fuse Holder	#14 AWG (2.5 mm ²)	#8 AWG (25 mm ²)
Communication Connectors	#22 AWG (0.5 mm ²)	#16 AWG (1.5 mm ²)
PV Input Glands	—	Up to 7.7 mm diameter

*AWG size conversions are listed to the closest equivalent mm² commercial size.

Installation

Wiring Drawing

IMPORTANT: Example only. This illustration depicts a negatively-grounded system. Actual wiring may vary. All configurations must comply with local and national electric codes. Consult local electric authorities to ensure compliance.

Communications Wire Length

Wire Size	Length
#16 AWG	200'
#18 AWG	125'
#20 AWG	80'
#22 AWG	50'

NOTE: These are the maximum allowed lengths are for the entire run of communications wire, including between additional combiners and other devices.

SkyBox

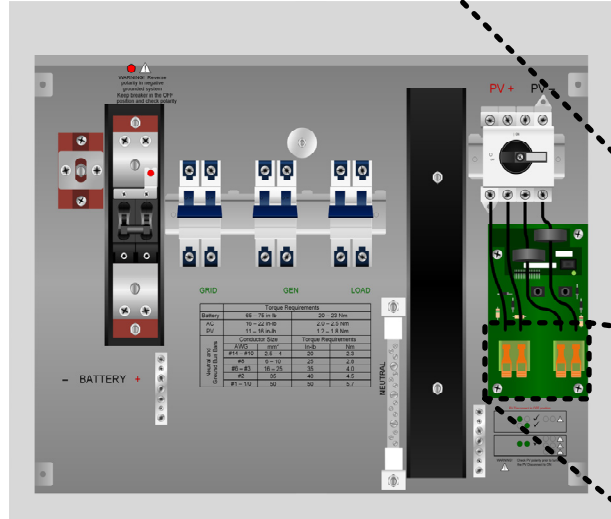
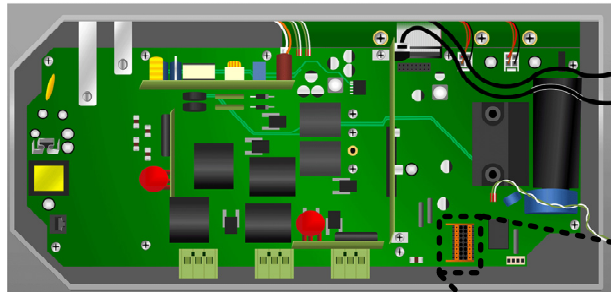

48 Vdc from battery supply + -

Example of Class 2 power supply



Photovoltaic (PV) Array

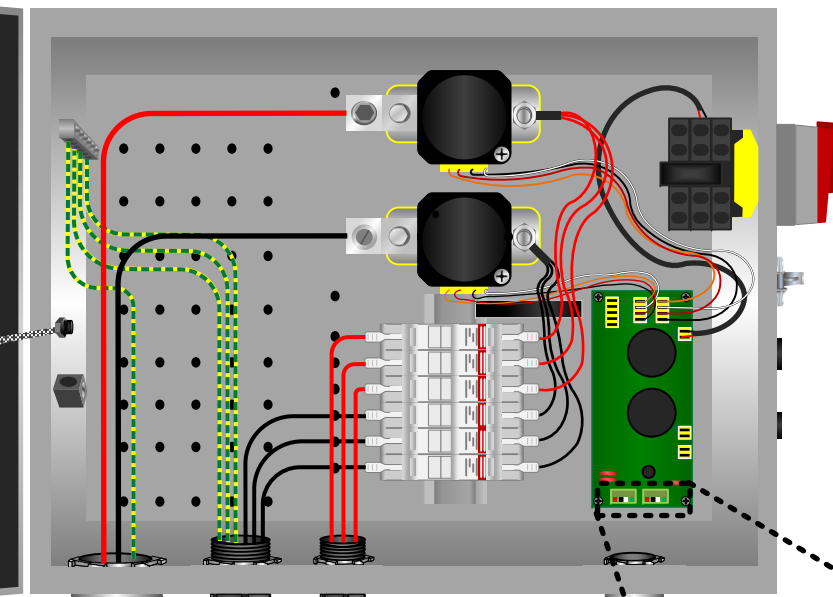
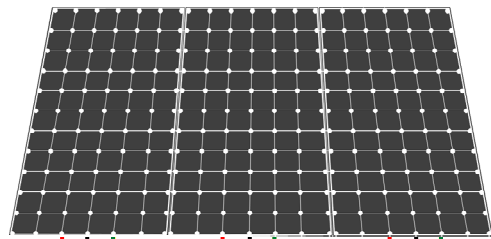

Sealing Nuts

NOTE: These wires may be routed through the PV conduit as long as they are rated for the maximum PV voltage.

IMPORTANT: This jumper is required for correct operation.

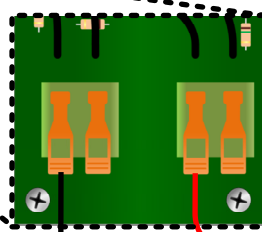
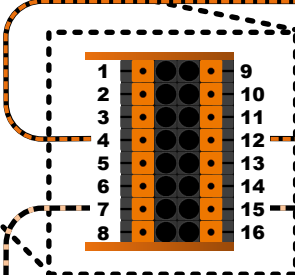
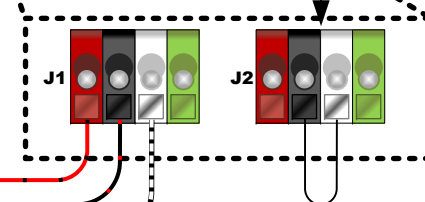

Ground Electrode Conductor

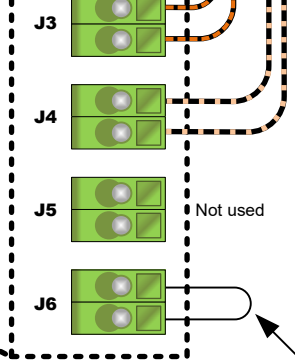
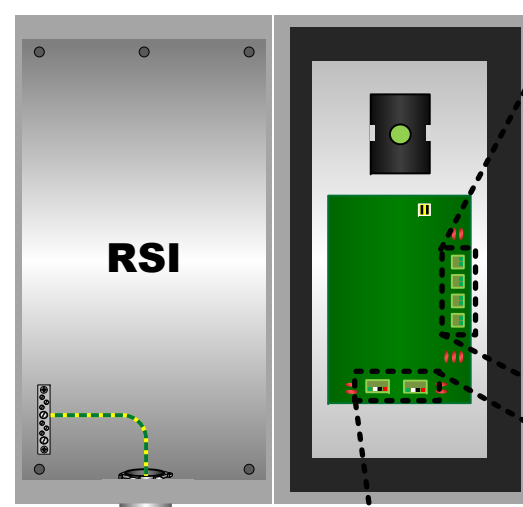

NOTE: Insert individual wires into each circular hole. Press on the slot with a narrow tool to unlock each opening.

IMPORTANT: This jumper is required for correct operation.

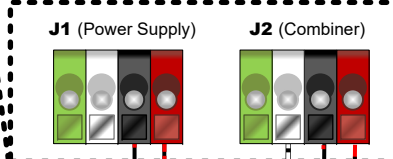

DC LEGEND		
PV Negative	⊖	Black
PV Positive	⊕	Red
Ground	⊕	Green
24V RSI Supply Positive (+)		Red/Black
24V RSI Supply Negative (-)		Black/Red
24V Combiner Supply Positive (+)		Red/Black
24V Combiner Supply Negative (-)		Black/Red
PV RSI Safe		Black/Black
J3 to Aux		Orange/Black
J4 to Aux		Black/Black

Multiple Combiners

Up to six combiners can be used with a single Rapid Shutdown Initiator. The RSI can be used as an emergency shutoff for all of the six systems. Six combiners can be powered by a single RSI and power supply.

Connect the control wires of additional combiners in series with the first combiner (designated **1** below). The **J1** terminals for **1** are connected to the RSI as shown on the previous page. The **J2** terminals are connected to the **J1** terminals on **2**. The **J2** terminals on **2** are connected to the **J1** terminals on **3** if present, and so on.

NOTE: **J1** and **J2** are interchangeable in the combiner and can be reversed if necessary. (See the connections between **3** and **4** below.) This statement is only true for combiner boxes.

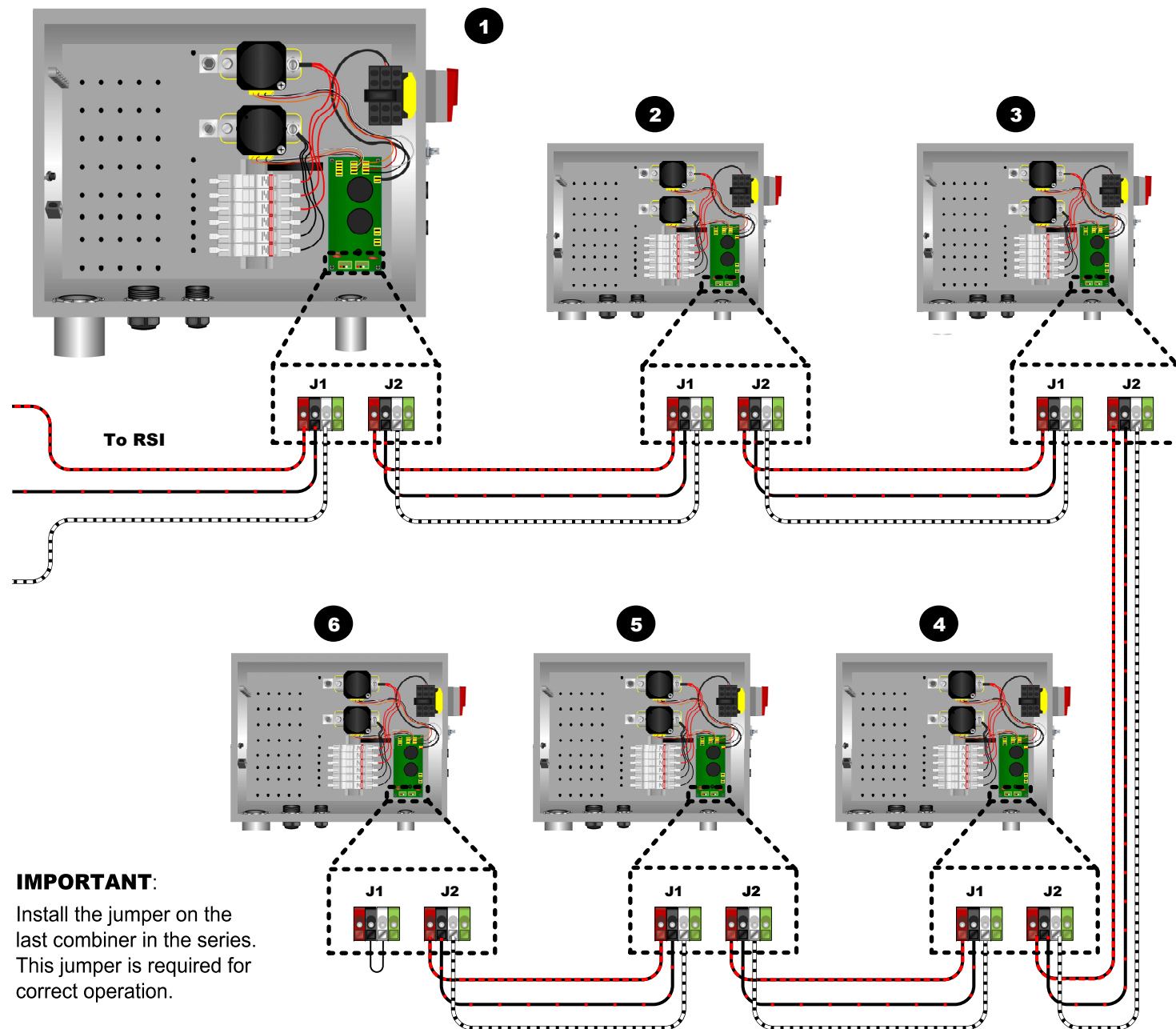

IMPORTANT:
Install the jumper on the last combiner in the series. This jumper is required for correct operation.

Surge Protector

An optional surge protection device can be installed in the combiner. A knockout has been provided to accommodate this type of device. This image shows the underside of the combiner and the location of the knockout.

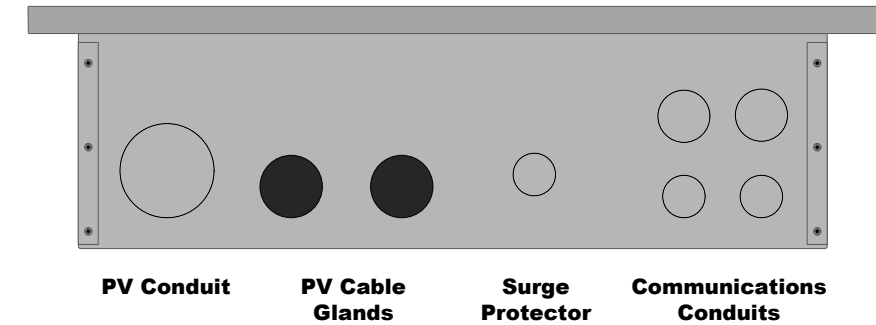

NOTE: Any installed devices must be liquid-tight to sustain the combiner's environmental rating.

Date and Revision

August 2021, Revision B

Trademarks and logos are the property of EnerSys and its affiliates unless otherwise noted. Subject to revisions without prior notice. E. & O.E. UL® is the registered trademark of UL LLC. NFPA® is the registered trademark of National Fire Protection Association, Inc.