



Contour™ Trim

Aesthetic Arrays, Sleeker All Around

Homeowners want the solar on their home to meet their energy needs, while not detracting from their home's aesthetics.

IronRidge Contour™ Trim elevates the look of any array by providing sleek trim across the south edge or around the perimeter to hide components that are visible beneath the solar panels.

Contour™ installs quickly and easily, reducing time on the roof. The C-shaped Clamp attaches directly to the bottom flange of modules, with T30 Torx bolts that minimize the gap between the Trim and array.

Simply put, Contour™ will make any array look great, and have your crew on and off the roof in a snap.

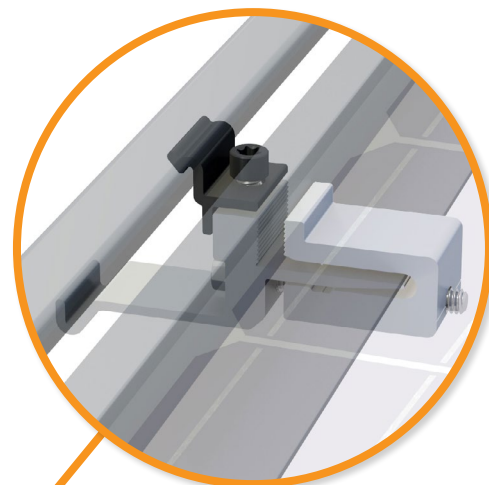

Universal Module Clamps

The Clamp's unique design lets it easily secure onto the bottom flange of almost any module. Trim segments are placed into the open tray of the Clamp and then aligned. T30 Torx bolts lock the Trim into place, while minimizing visible gaps.

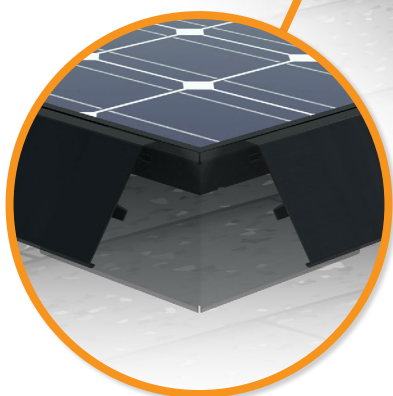
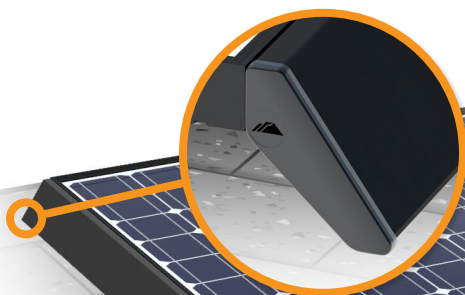

Wraparound Array Options

The Contour™ components allow for custom-fit installations, to meet the needs of any array. Inner and Outer Corner Caps seamlessly transition Trim around corners, while End Caps provide clean ends.

Cross-Compatible Design

Contour™ was designed to go just about anywhere: tile, metal or shingle pitched roofs. That means solar installers can revisit any past projects and offer an upgrade to the aesthetics of the system.

NOTE: A hidden end clamp, like CAMO®, must be used with Contour™ when wrapping around arrays and for the best aesthetics.



Contour™ Components

Contour™ Trim

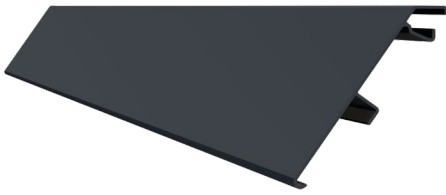

Trim comes in 84" lengths of black powder-coated aluminum. Pieces can be cut to length to fit the array edge.

Contour™ Splice



The Splice connects two pieces of Trim together, tool-free. Trim easily slide and can be pushed into place.

Contour™ Clamp

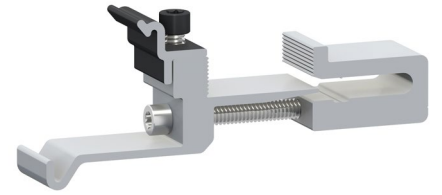

The Clamp secures to bottom flange of most modules. T30 Torx bolts used to reduce visible gaps (bit included).

Contour™ Outer Corner Cap

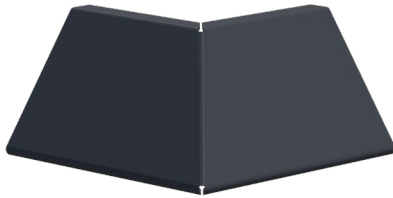

The Outer Corner Cap easily slides onto Trim, without any tools, to wrap Trim around outside array corners.

Contour™ Inner Corner Cap



The Inner Corner Cap easily slides onto Trim, without any tools, to wrap Trim around inside array corners.

Contour™ End Caps



The Ends Caps are a pair, for the left and right side of Trim. Equipped with a metal clip, they grip firmly in place.

Array Configurations

Contour™ provides fully-customizable options. Trim and End Caps can cover the south edge while Corner Caps can extend the Trim to wrap around the sides.



Configuration #1: Southern Array Edge



Configuration #2: Simple Array Wraparound

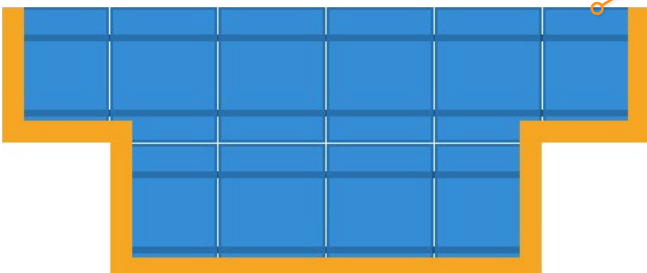

Configuration #3: Complex Array Wraparound

Bill of Materials			
Accessories			
<input type="checkbox"/> Contour end caps			
Part	Spares	Total Qty	
Accessories			
CTR-TR84-01-B1 Contour Trim	0 edit	9	
CTR-CL-01-B1 Contour Clamp (incl. Torx bit)	0 edit	18	
CTR-SPLC-01-M1 Contour Splice	0 edit	2	
CTR-IN-01-B1 Contour Corner Cap, Inner	0 edit	2	
CTR-OUT-01-B1 Contour Corner Cap, Outer	0 edit	4	

Contour™ Clamp Module Compatibility

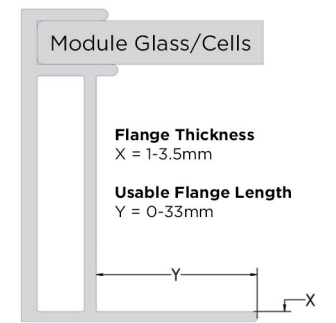

The Clamp has been tested or evaluated with all modules having frames in the above referenced dimensions. Make sure modules being used meet these dimension requirements.