

17721 SS

17664, 17720

LOW PROFILE QUICKBOLT WITH 4" MICROFLASHING®
FOR ASPHALT SHINGLE ROOFS
PATENT # 8448407

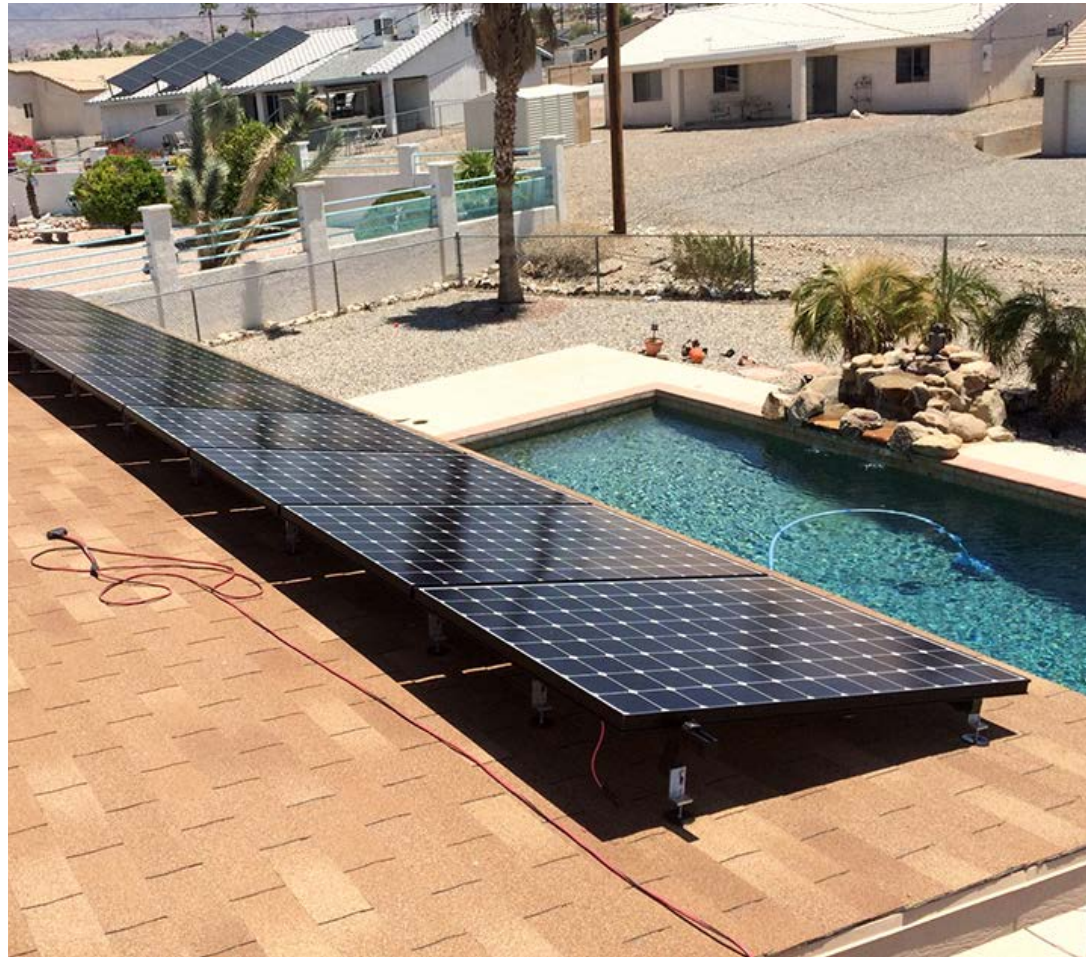

A DIVISION OF QUICKSCREWS INTERNATIONAL CORP

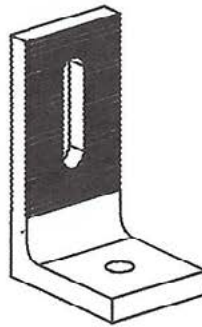
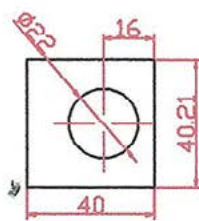
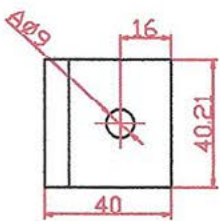
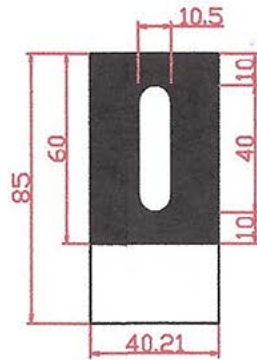
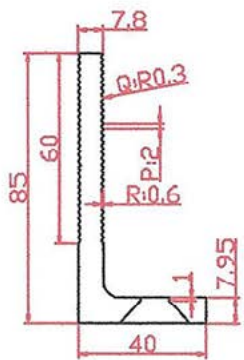

Baiting tolerance	± 2 mm
Hole tolerance	± 0.5 mm
Hole distance tolerance	± 0.5 mm
Form tolerance	± 2 mm
Thickness tolerance	± 0.1 mm
Angle tolerance	$\pm 1^\circ$ mm

SPEC SHEET

Part #	Box Quantity
17664	5.25" Bolts (10)
17720	4" Microflashing® (10); 5.25" Bolts (10)
17721 SS	4" Microflashing® (20); 5.25" Bolts (20); L-Foot (20); 5/16" Serrated Hex Flange Nuts (20)



Part #17664

5/16-18 X 5.25"
304 Stainless Steel
Removable Hanger Bolts

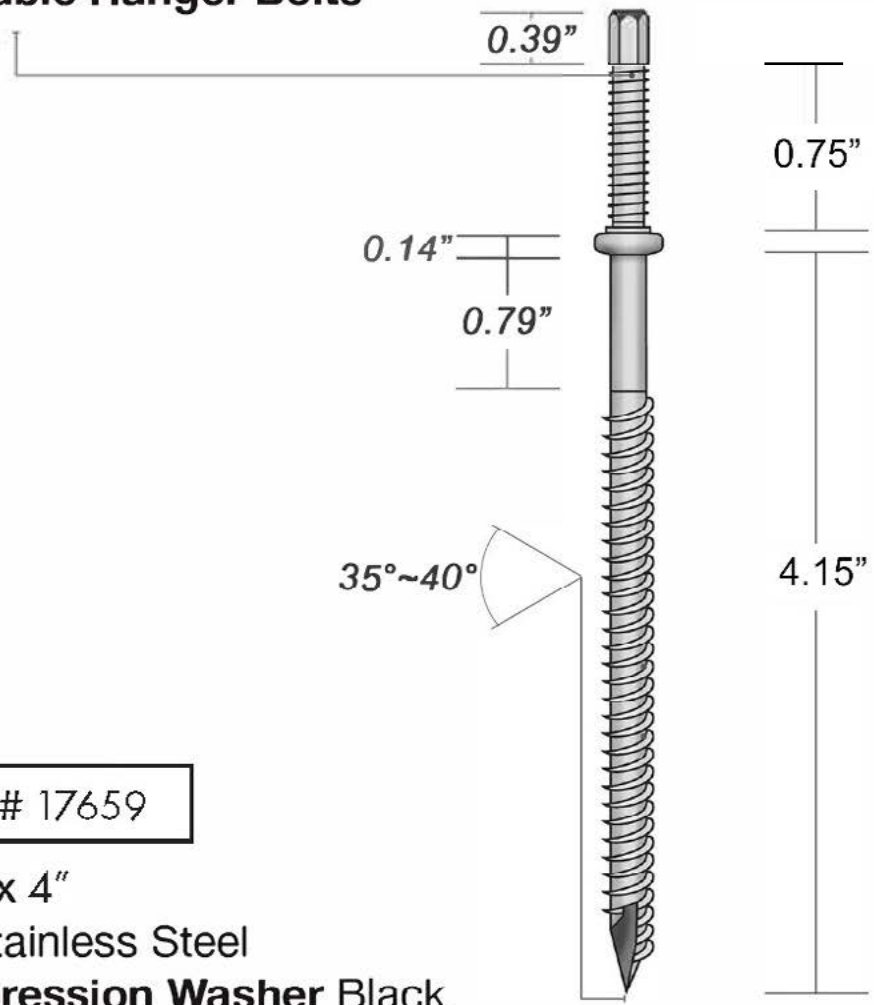

Part # 17659

5/16" x 4"
304 Stainless Steel
Compression Washer Black

